



Producer
of Pneumatic Advertising



#CreateYourBrand

www.poltent.pl



PRODUCT CATALOG

HOW TO PROMOTE A BRAND THAT WILL ATTRACT THE CROWDS?



When in 2005 we decided to release our first inflatable, we did not expect that in such a short time we could achieve such a great success in the field of outdoor advertising. Years of experience in the pneumatic advertising industry have taught us that there is a way for everything.

Does the pneumatic advertising producer sound scary? Think of us as a guide, a friend who will safely lead you through the paths of your event travel. We are not only about producing advertising media, we select the right solution for each client to meet their expectations.



#CreativeEvents

#CreateYourBrand



We know how important it is to have fun during the events. Especially at events where the customer likes to be surprised at every turn, creativity counts. We are full of ideas and effective solutions and we are not afraid of even the biggest challenges.



#CustomizedInflatables



#Outdoor



In Poltent, we are not afraid to combine fantasy and the real world. It was like that at the beginning and it is today. No matter what challenges will get in our way, what requirements the client will throw at us, we will be ready for them together.

#CreateYourBrand



We would like to know that the inflatable structures can be in many different colours and are full of surprises that will even enchant the most demanding guests. We transform your needs into solutions.



Presenting you with this catalogue, we would like to brief you a wide range of services we offer and the possibilities of using pneumatic advertising in the event area. Are you ready to go for gold?

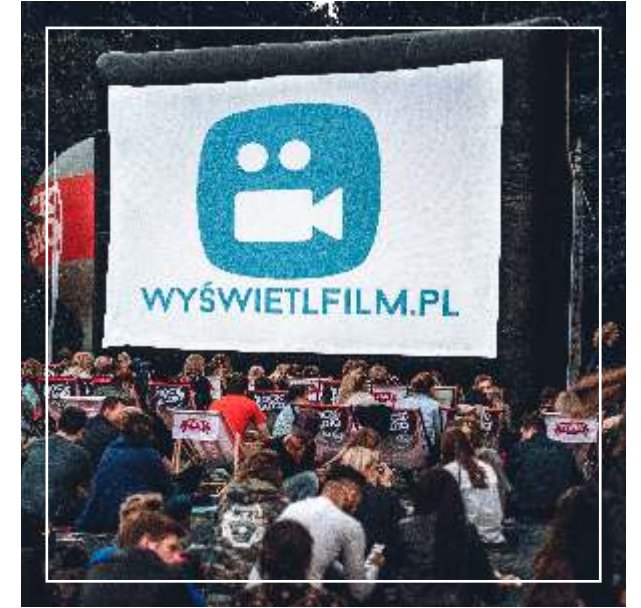

#WhereverYouWant



#Poltent

#CreateYourBrand

- GATES -
*the beginning
of an exciting
adventure*





PORTALS OF JOY

Create positive vibes! A gate is more than just an advertising space where you can display your logo at every event. This is a real "Portal of Joy" which takes people to a better place! This is

clearly seen during concerts and sports events, where thousands of people come to fulfil their dreams. The gate opens space for people and puts your company right in the center of events.



DIMENSIONS

model	Sinus (Small)	Sinus (Big)	Rectangular (S)	Rectangular (B)	Polygonal (S)	Polygonal (B)	Arched (S)	Arched (B)
External Dimensions [m]	8,00 x 4,00	11,20 x 5,60	8,00 x 4,00	11,20 x 5,60	8,00 x 4,00	11,20 x 5,60	8,00 x 4,00	11,20 x 5,60
Internal Dimensions [m]	5,60 x 2,80	8,00 x 4,00	5,60 x 2,80	8,00 x 4,00	5,60 x 2,80	8,00 x 4,00	5,60 x 2,80	8,00 x 4,00
H&L* Fields on Cross-Beam [m]	3,50 x 1,00	5,00 x 1,30	5,00 x 1,00	7,00 x 1,30	3,50 x 1,00	5,00 x 1,30	n/a	n/a
H&L* on Legs [m]	1,00 x 1,50	1,30 x 2,00	1,00 x 2,00	1,30 x 3,00	1,00 x 1,50	1,30 x 2,00	n/a	n/a
H&L* Fields on Slants [m]	n/a	n/a	n/a	n/a	1,00 x 1,00	1,30 x 1,30	n/a	n/a
H&L* Fields - 1 module [m]	n/a	n/a	n/a	n/a	n/a	n/a	1,36 x 1,00	1,40 x 1,20

*H&L - Hoop and Loop



AN UNUSUAL TENT

Do you care about a good company image and great relations with business partners? Would you like to attract attention at the event and at the same time show off your best side? Go for inflatable tents! A tent is not only an advertising space, but also a wonderful meeting place. This

is a place where you can make contacts, invite guests or potential customers for a coffee and tell them about your company's plans. A tent is a perfect solution and offers a constant element at most events.

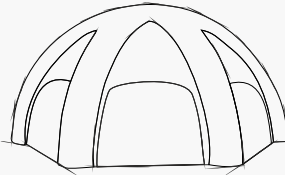

SPIDER TENT

model	4-legged	4-legged	4-legged	4-legged	5-legged	5-legged	6-legged	6-legged
Size [m]	4 x 4	5 x 5	6 x 6	8 x 8	-	-	-	-
Tent Diameter [m]	-	-	-	-	fi 8,3	fi 10	fi 8,3	fi 10
External Height [m]	3,00	3,70	4,40	6,00	4,60	5,60	4,60	5,60
Internal Height [m]	2,40	3,00	3,50	4,85	3,65	4,45	3,65	4,45
Usable Area [m ²]	ok.11	ok.19	ca. 29	ca. 50	ca. 32	ca. 47	ca. 32	ca. 47



SIX-LEGGED SPIDER TENT

#CreateYourBrand



MODIFY AS YOU LIKE!
DIFFERENT TYPES OF WALLS,
THREE-DIMENSIONAL LOGOS,
LED LIGHTING



SPIDER TENT
WITH 3D LOGO ON THE TOP

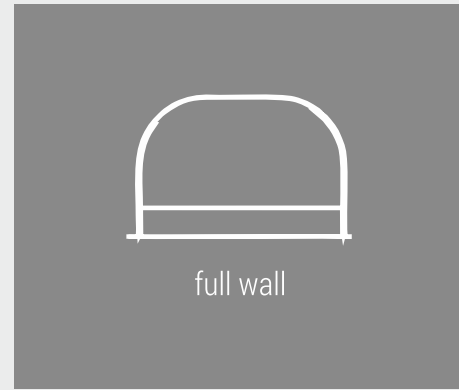
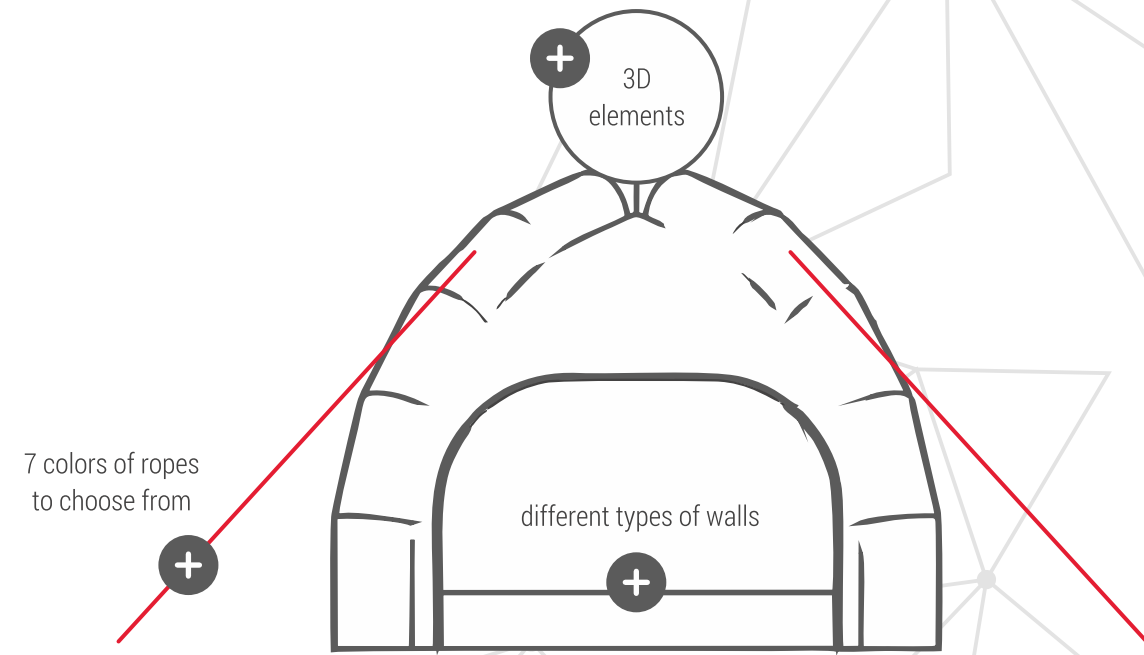

full wall

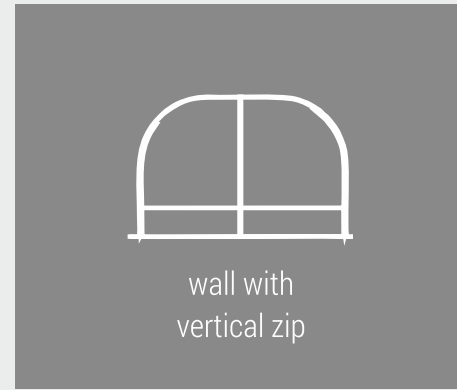

wall with
vertical zip

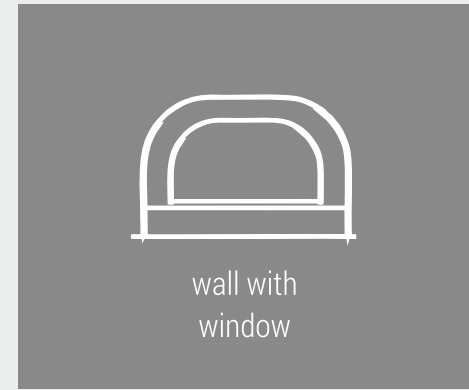

wall with
window



SIT BACK AND RELAX

Advertising poufs with digital printing are practical accessories to many events, both indoors and outdoors. Beanbags are perfect as

equipment for tents and outdoor cinema. And if this is not enough for you, how about some huge cushions, cubes or comfortable chairs?

DIMENSIONS

model	d. [cm]	width [cm]	depth [cm]	height [cm]
Bag S	70	-	-	105
Bag M	85	-	-	105
Bag L	100	-	-	95
Big Pillow (XL)	-	180	-	140
Chair Classic	-	60	85	105
Chair Round	85	-	-	105
Cube 40	-	40	40	40
Cube 50	-	50	50	50





OPEN-AIR CINEMA

How about breaking the rules? It is so simple with the projection screen. Surprise everyone and organize an outdoor cinema! Show people cult movies, football games, athletics championships, volleyball. Remember that the

projection screen can also be used on full of excitement snowy slopes during the winter. Our projection screen is not only a great promotion tool, but also a guarantees of great fun for those who love sports events or open-air cinema.



FOR LONG MOVIES
WE RECOMMEND
COMFORTABLE POUFS!

SCREEN WITH NET
FOR FRONT PROJECTION

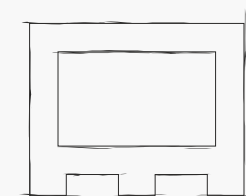

DIMENSIONS

model	S	M	L	XL
Screen Size [m]	5,20 x 3,95	7,00 x 4,90	9,50 x 6,50	11,3 x 8,10
Projection Screen Fabric Size [m]	4,25 x 2,50	6,05 x 3,45	8,17 x 4,67	10,00 x 6,00
Advertising Area [m]	4,25 x 1,00	6,05 x 1,00	8,17 x 1,15	10,00 x 1,45
Leg Diameter [m]	0,95	0,95	1,30	1,30



STATIONARY BALLOON
ALFA MODEL

CLASSICS IN THE OUTDOORS

Trigger positive emotions and show your best side! Choose classic advertising balloons, and we will do our best to make your brand visible at every event. The balloon is not only an accessory

to an outdoor event, competitions, concerts or trade fairs. Most of all, it guarantees a positive effect. Do you want something more? Use our balloon potential and enjoy your event.



ALFA

Height [m]	2,0	3,0	4,0	5,0	6,0	8,0
Advertising space [m]	0,6 x 4,8	0,9 x 7,2	1,2 x 9,6	1,5 x 12,0	1,8 x 14,4	2,6 x 16,6
Diameter at the equator [m]	1,5	2,3	3,1	3,8	4,6	5,3



BETA

Height [m]	2,0	3,0	4,0	5,0	6,0	8,0
Advertising space [m]	0,55 x 4,5	0,8 x 6,7	1,1 x 9,0	1,4 x 11,3	1,7 x 13,5	2,8 x 16,0
Diameter at the equator [m]	1,4	2,1	2,9	3,6	4,3	5,2



ACCESSORIES FOR BALLOON:

- STABILIZER
- LED LIGHTING
- EXCHANGEABLE BANNERS



STATIONARY BALLOON
ALFA MODEL



GAMMA

Height [m]	2,0	3,0	4,0	5,0	6,0	8,0
Advertising space [m]	0,65 x 5,3	0,95 x 7,9	1,3 x 10,5	1,6 x 13,2	1,9 x 15,8	2,6 x 21,3
Diameter at the equator [m]	1,7	2,5	3,3	4,2	5,0	6,8



DELTA

Height [m]	2,0	3,0	4,0	5,0	6,0	8,0
Advertising space [m]	0,7 x 4,0	1,0 x 6,0	1,4 x 8,0	1,7 x 10,0	2,1 x 12,0	2,80 x 16,00
Diameter at the equator [m]	1,3	1,9	2,6	3,2	3,8	5,20



GET YOUR IMAGE STARTED

Curiosity... sold the cat! Each of us knows how important the first impressions is. Sometimes a few dozen seconds decide how we will be remembered for years. If you confident in the role of welcoming quests, Hello Man will do it for you! He can be a cook inviting quests to the land of

amazing taste sensations. He can be Mr. Ice Cream Cone, who will take your customers to the refreshing world of ice tastes, or Mr. Seal, who with a pleasant gesture will show the direction to the place where you can meet these cute creators. It can also be used as a replica of your products.

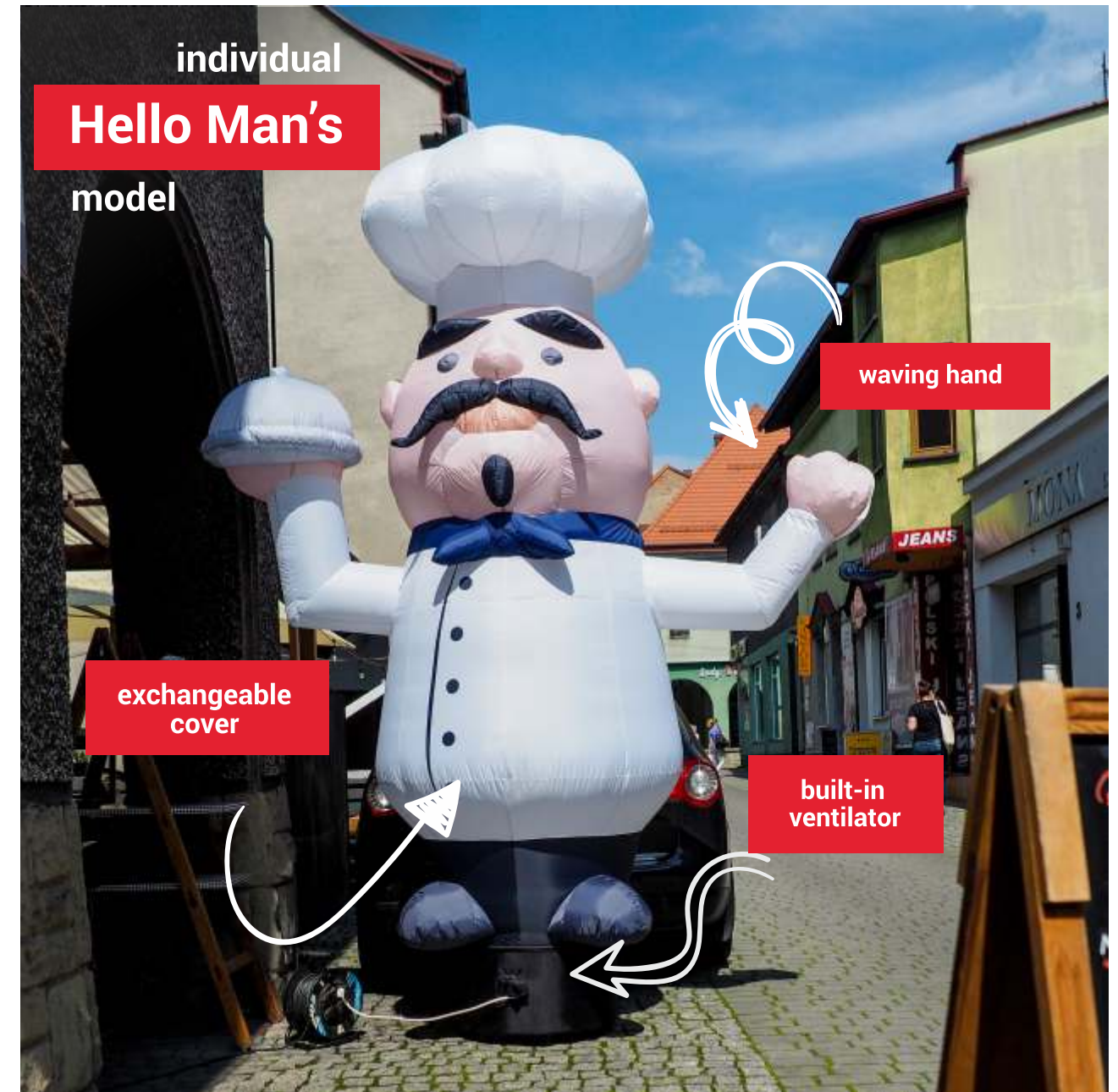



HELLO MAN
SUPERHERO
FOR SPECIAL
TASKS

The one who stands still does not develop. Therefore, go for movement! Catch hundreds of interested glances in the event network and make them your friends – who wouldn't want to be friends with a superhero?



DIMENSIONS

Standard height [m]	3,50
Size after packing [cm]	65 x 65 x 50 (L x W x H)
Weight* [kg]	17
Base diameter [cm]	60
Ventilator power	225 W

* without mounting kit

LET US SURPRISE YOU!

Impress at the event with an inflatable! Let yourself be carried away and create the inflatable of your dreams. How would you feel about a big inflatable car, dart or gate in the shape of your company's logo?

#CreateYourBrand





FROM IDEA
TO IMPLEMENTATION

INSPIRE YOURSELF!



Custom products always make a good impression and bring positive emotions to events.

Especially nowadays, as people have higher expectations, you cannot allow for boredom to set in.

#CreateYourBrand



HIGH IN THE SKY

How about flying high in the sky? The helium balloon is an impressive advertising medium that will present your brand in an original way. This is an attraction that makes a great impression at every event. Just fill the balloon and it can rise up to 25 meters high. A helium balloon is a unique

medium that also works well indoors. When helium structures float under the ceiling, the interior takes on a spectacular appearance! Do you want the WOW effect? The helium balloon is the perfect solution for you.

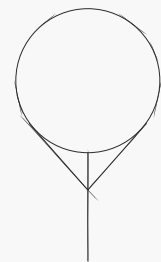

HELIUM BALLOONS

size [m]	2,5*	3,0*	3,0	3,5	4,0	4,5	5,0	5,5	6,0
volume [m ³]	8	14	14	22	33	48	65	87	113
Maximum Load [kg]	2,5	5,1	4,5	9	17	27	41	58	78

* single shell balloon

HELIUM BALLOON
WITH EXCHANGEABLE COATING



HELIUM BALLOON
WITH EXCHANGEABLE COATING



HUGE SPACE

Making an investment in an advertising screen is always a good decision. The huge screen surface creates many advertising possibilities. The advantage of the screen is also its mobility. This gives you the possibility to advertise in a variety

of places. On the screen you can present your logo, advertising slogan, you can place an interesting photos, etc. You can actually show what is the most important to you.



ADVERTISING SCREEN
WITH EXCHANGEABLE GRAPHICS

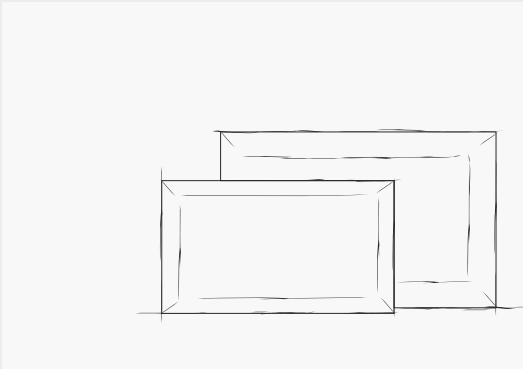

ADVERTISING AIRWALL

model	small	big
Screen Size [m]	7,00 x 4,00	8,30 x 5,30
Grid Size [m]	6,00 x 3,00	7,00 x 4,00
Leg Diameter [m]	1,00	1,30



FLUTTERING FLAG

The devil is in the detail! Therefore, when you've organized everything for your event, you already have your dream tent, gate, projection screen and advertising balloons, it's also good to take care of

flags. If there's a light breeze or gusty wind - thanks to our flags your logo will flutter in the wind.

ADVERTISING FLAGS



Model	Rider			Rider Round			Flyer		
Size	S	M	L	S	M	L	S	M	L
Flag size [m]	0,8 x 1,60	0,8 x 2,60	0,8 x 3,60	0,8 x 1,6	0,8 x 2,6	0,8 x 3,60	0,9 x 1,35	0,9 x 2,35	0,9 x 3,30
Mast height [m]	2,00	3,10	4,20	2,00	3,10	4,20	1,75	2,80	3,90

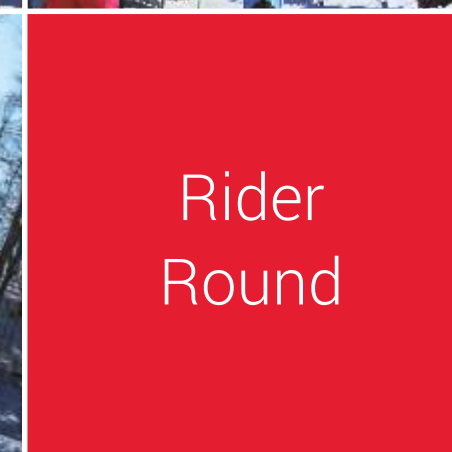
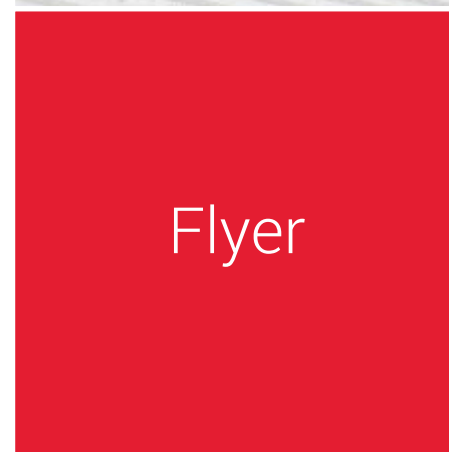
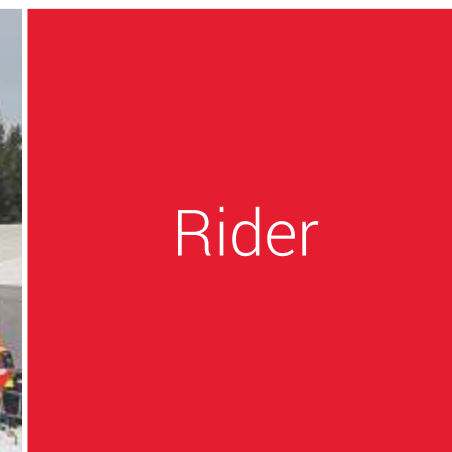



DANCING IN THE WIND!

Are you looking for an inflatable that will attract the crowds and improve the mood the event? What would you say about windyman? He dances in the wind, rocks to the rhythm of music and invites you with a smile to have some fun together. Windyman is much more than just an advertising medium.

ONE AND TWO-LEGGED
WINDYMAN

#CreateYourBrand



CONSTANT PRESSURE PRODUCTS

In order to meet your expectations, we have developed VENTO® line – range of modern constant pressure products.

Constant pressure products (also called air-tight) are inflatables, which because of the hermetic modules filled with air, allow us to display advertising, without any need of using ventilator, which also makes them very quiet advertising medium. VENTO® products are the new dimension of events! No more worries about constant access to electricity, therefore they are perfect for using both indoors as well as outdoors.

It's very simple to change graphics in VENTO® products, by using exchangeable sheating. In VENTO® line assortment you will find light and modern tents, functional gates, screens, practical advertising pillars and furniture like promotion counters, tables, chairs and sofas.



VENTO® GATE WITH 3D ELEMENT

CONSTANT PRESSURE PRODUCTS

#CreateYourBrand



MODERN DESIGN

VENTO® tent is based on four modules filled with air and covered with polyester fabric, which you can freely print (by sublimation). The sheathing consists a roof and walls which are mounted with the roof with a handy zippers.

VENTO® TENT



VENTO® TENT WITH CONNECTORS

DIMENSION

model	3 x 3	4 x 4	5 x 5	6 x 6	7 x 4	10 x 6
usable area	7 m ²	15 m ²	22 m ²	30 m ²	17 m ²	41 m ²
advertising area	37,5 m ²	40 m ²	65 m ²	86 m ²	51,6 m ²	79 m ²
external height	2,65 m	2,90 m	3,60 m	4,25 m	2,65 m	2,90 m
internal height	2,40 m	2,65 m	3,30 m	3,90 m	2,40 m	2,65 m
entrance height	2,00 m	2,20 m	2,50 m	2,80 m	2,00 m	2,20 m
entrance width	2,75 m	3,70 m	4,50 m	5,20 m	2,75 m	3,70 m



MODEL VENTO® SIX

Modify as you want!

Different types of walls, matched to your needs.

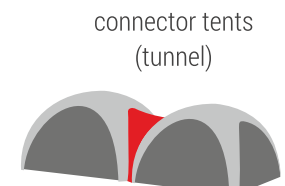
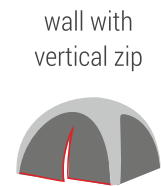
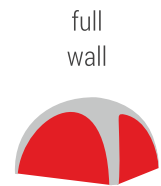



VENTO® SIX TENT

THE 6 SENSE OF YOUR EVENT

Have fun with the form and mix many VENTO tents to create event towns about which sublime songs will be sung. Thanks to the 6-leg system, nothing disturbs its balance, and no need for a constant power connection gives you unlimited display options. Lightweight, cable-free and stable construction will ensure maximum advertising space. You, the audience and your brand in the spotlight.

What can we say - other tents can hide under it!



VENTO® SIX TENT



Wherever You want!



AT ANY TIME

#CreateYourBrand



VENTO[®] CUBE TENT

Are you looking for a tent that will make your event reach a level from 0 to 100? Look no further. The VENTO[®] Cube advertising tent will make you stand out from the crowd. Not only will it give you the opportunity to display your company logo and make a permanent impression on your customers, but also... it will allow you to sleep inside it! The perfect promotion of your brand while giving you the opportunity to sleep well after the event until dawn - isn't that special?

The VENTO[®] Cube tent has a huge advertising surface that will allow you to show your best side and you will not remain unnoticed, even for the least observant event participants.

DIMENSIONS

usable area	4 m ²
width of the tent	2,50 m
the length of the tent	2,50 m
external height	2,45 m
internal height	2,20 m
entrance width	2,00 m
entrance height	2,00 m
weight of the tent with a set of walls*	18, 4 kg

* without mounting set



unique design

integrated-non-slip floor

ready in 1,5 min.

a huge 25m² advertising space

VENTO[®] CUBE TENT

Whenever You want!

#CreateYourBrand

VENTO® SCREEN

How to show yourself better from all sides and delight the event participants? Go for emotions of great format! The VENTO® advertising screen is a solution that will give your event a unique style that will be remembered for a long time.

Thanks to the modern design and mobility of the VENTO® advertising screen, you will take the promotion of your brand to a completely new level.

Due to using exchangeable polyester sheating in VENTO® media, you can easily change the graphics for your next event. Plan your event today!



VENTO® Screen

Standard size:

- 3,00 x 4,00 m

- 4,50 x 6,00 m

VENTO® TABLE & COUNTER



Wherever You want!



Stolik kawowy
0,55 x 0,60 m [wys. x szer. x gł.]

Coffee table



Event table
1,00 x 0,60 m.
[H x W]

Event table



Unusually shaped counter
1,00 x 1,60 x 0,90 m [H x W x D]

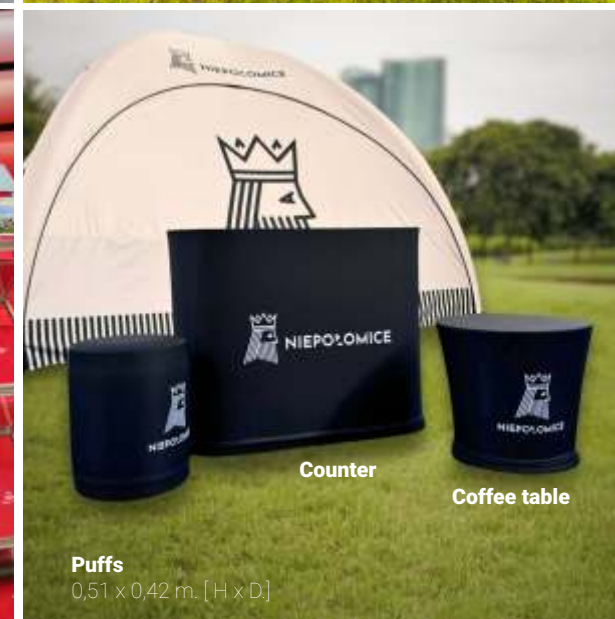

Counter (stand)
1,00 x 1,20 x 0,45 m.
[H x W x D]

Coffee table
0,55 x 0,60 m.
[H x W]

Puffs
0,51 x 0,42 m. [H x D]

Counter

Coffee table

VENTO® CHAIR & SOFA



**Turn the event
meeting place into
a spectacular
show.**

The VENTO® chair and sofa are perfectly complementary products, ensuring your brand not only the space and the form of top-class advertising. These are inflatable works of art, allowing the event participants to experience moments of relaxation that words known to humanity will not describe. Easy to transport, no fan required. Thanks to the chairs and sofas from VENTO® line, you will make your customers feel royal.



VENTO® chair
0,85 x 1,04 x 1,20 m
[height x width x depth]

Wherever You want !



VENTO® Sofa
0,80 x 1,70 x 1,10 m
[height x width x depth]

VENTO® PILLAR

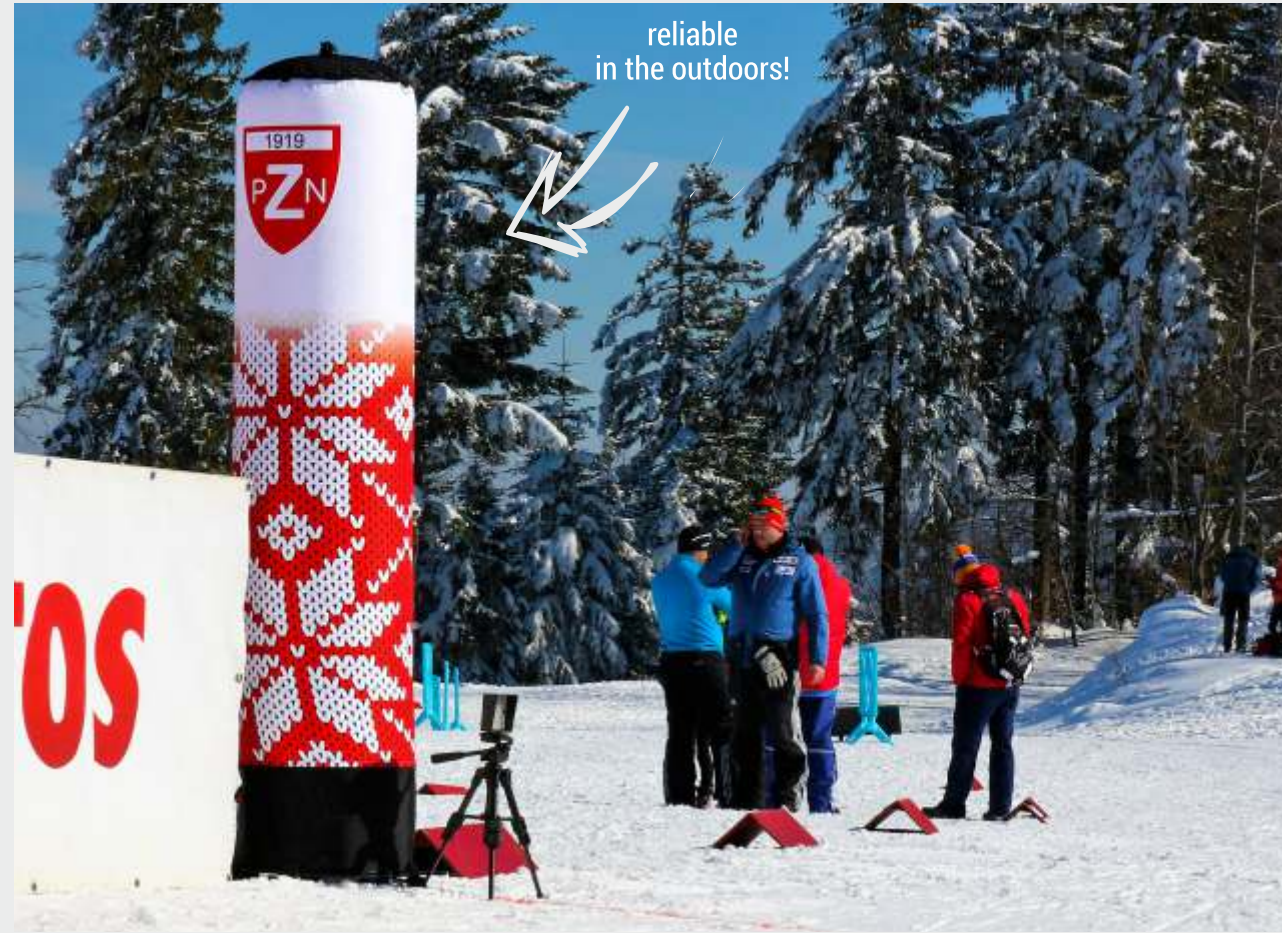

reliable
in the outdoors!

NO POWER, NO CABLES
wherever you want!

DIMENSION

height	diameter
2,00 m	0,45 m
2,50 m	0,45 m
3,00 m	0,60 m
3,50 m	0,60 m
4,00 m	0,95 m

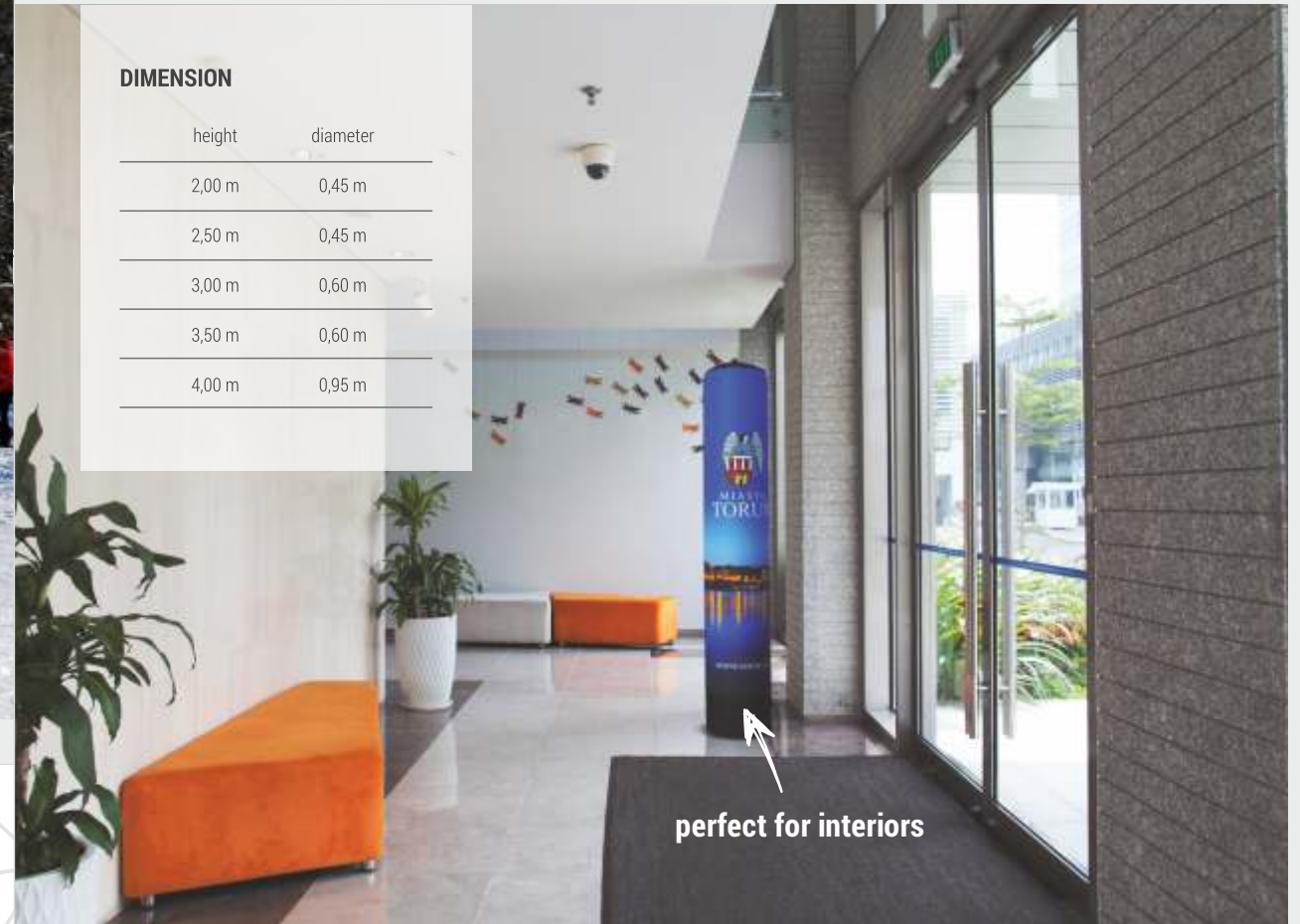

perfect for interiors



VENTO® GATE



**Floating gate
with skids.**



One gate, so many possibilities!

Customize the gate to your needs, choose from VENTO® Basic or VENTO® Plus gate. Constant pressure VENTO® Plus gate has exchangeable sheathing (with unlimited sublimation printing) in its set. VENTO® Basic is a constant pressure gate, which doesn't have exchangeable cover.



DIMENSION

size	S	M	L
external dimensions	4,40 x 2,95 m	6,20 x 3,60 m	7,90 x 4,45 m
internal dimensions	3,50 x 2,50 m	5,00 x 3,00 m	6,00 x 3,50 m
leg diameter	0,45 m	0,60 m	0,95 m
hook and loop fields on cross-beam	2,00 x 0,50 m	3,00 x 0,75 m	3,50 x 1,00 m
hook and loop fields on legs	0,50 x 1,50 m	0,75 x 2,00 m	1,00 x 2,00 m
hook and loop fields on slants	0,50 x 0,50 m	0,75 x 0,75 m	1,00 x 1,00 m
length skid	2,00 m	3,00 m	4,00 m



#CreateYourBrand



#CreateYourBrand